

Majorana Double Beta Decay Search Project (Majorana Demonstrator)

Sergey Vasilyev

University of Tennessee, Knoxville

Outline

- Neutrino properties (short)
- Introduction to double-beta decay
- Majorana Demonstrator Project
- Summary

What we know (from ν oscillations):

- Neutrino flavour eigenstates differ from their mass eigenstates
- Neutrinos oscillate, hence they must have mass
- Mixing angles and Δm^2 values known (with varying accuracies)

What we don't know :

- Normal or inverted hierachy ?
- Dirac or Majorana particle ?
- CP violating phases in mixing matrix ?
- **No information about absolute mass scale ! (only upper limits)**
- Existence of sterile neutrinos ?

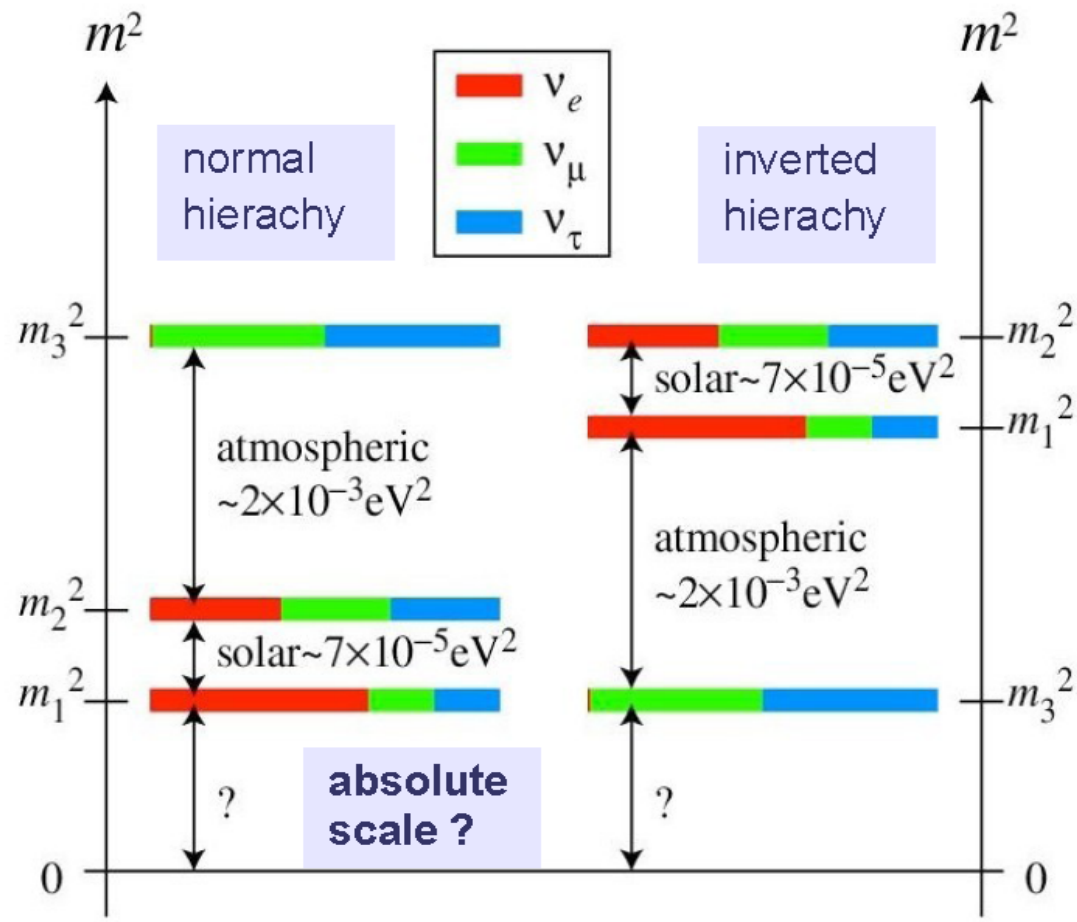

Dirac or Majorana particle?

How test of Majorana nature of neutrinos ($\bar{\nu} \equiv \nu$)?

- The key test originally proposed by G.Racah (1937):



Such a combination of events would violate the conservation of lepton number ($\Delta L=2$)

One way to study the Racah process is use real $\bar{\nu}$:

Ray Davis (1955) performed the famous $^{37}\text{Cl} \rightarrow ^{37}\text{Ar}$ reaction using anti-neutrinos from reactor

($\nu + ^{37}\text{Cl} \rightarrow ^{37}\text{Ar} + e^-$ - reaction for famous experiment with neutrinos from the Sun)

Can produce $\bar{\nu}$ indeed ^{37}Ar nuclei in reaction above?

“Rumors of a positive result reached Bruno Pontecorvo in Moscow in 1957 and caused him to invent neutrino oscillations in direct analogy with the Gell-Mann-Pais analysis of neutral Kaon decay. The rumors eventually died out but the idea of oscillations is still alive and kicking.” – S.P. Rosen (1992)

In 1957 with the discovery of parity nonconservation and the two-component neutrino, it was recognised that the two-step process of Racha is inhibited by helicity: the right-handed anti-neutrino emitted by the first neutron is in the wrong helicity state to be re-absorbed by another neutron.

In order to complete the second step of the Racah process, the anti-neutrino must be able to flip its helicity and turn itself into a neutrino.

- A much more sensitive method is to study double beta decay

Table1. Emission and Absorption of Neutrinos in the Standard Model

Process	Transition	Beta ray	Neutrino
Emission	$n \rightarrow p$	e_L^-	$\bar{\nu}_{eR}$
Emission	$p \rightarrow n$	e_R^+	ν_{eL}
Absorption	$n \rightarrow p$	e_L^-	ν_{eL}
Absorption	$p \rightarrow n$	e_R^+	$\bar{\nu}_{eR}$

Table2. Emission and Absorption of Neutrinos in a Modified Standard Model. The parameter η denotes small admixture of opposite helicities.

Process	Transition	Beta ray	Neutrino
Emission	$n \rightarrow p$	e^-	$\bar{\nu}_{eR} + \eta \bar{\nu}_{eL}$
Absorption	$n \rightarrow p$	e^-	$\nu_{eL} + \eta \nu_{eR}$

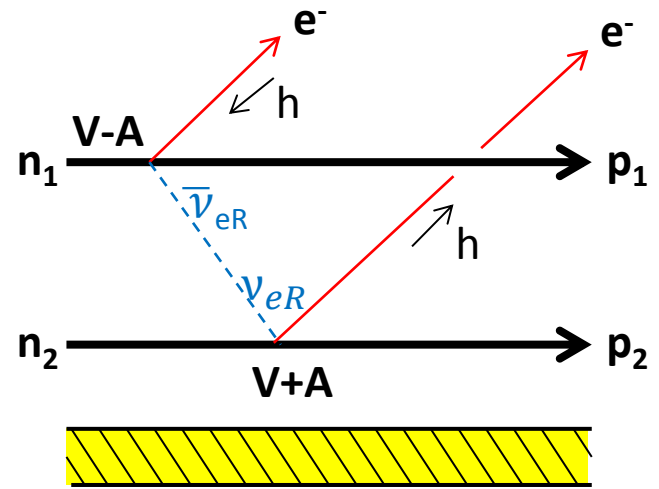
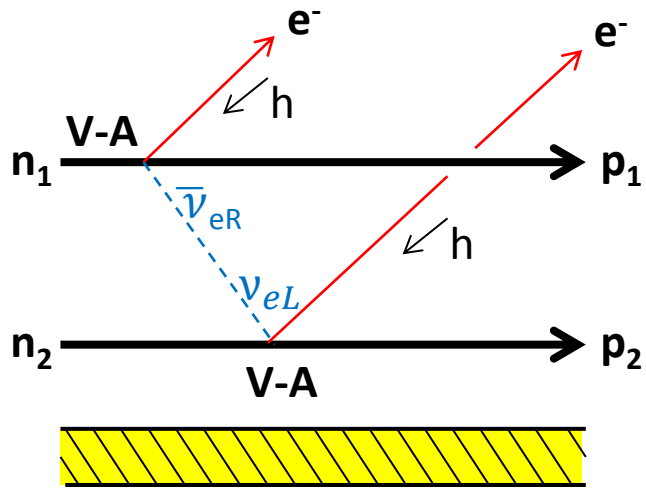

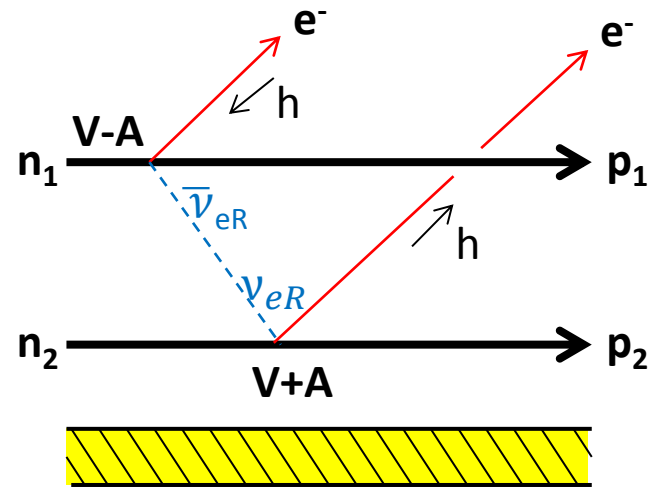
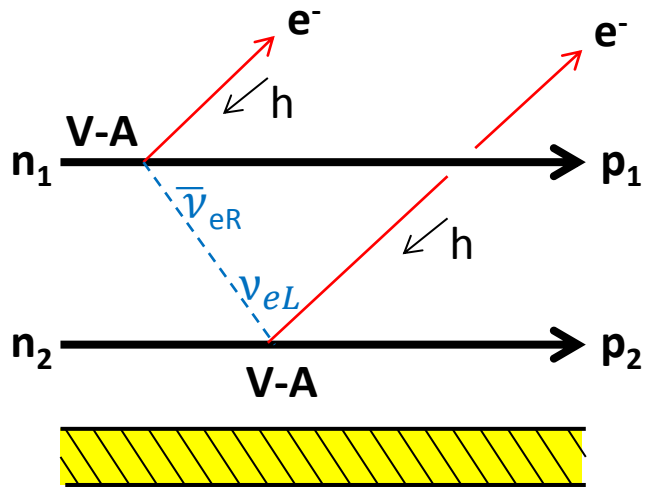

Important:

It can be treated the admixture of right-handed currents (RHC-mechanism) as a separate *phenomenological* mechanism for $0\nu\beta\beta$ decay. But it is not a separate *fundamental* mechanism. In gauge theories *the mass* is the fundamental mechanism for lepton number nonconserving processes: RHC- mechanism will not work unless there are mass term present in the neutrino mass matrix (**J. Schechter-J.Valle theorem**)

How to observe $\Delta L=2$

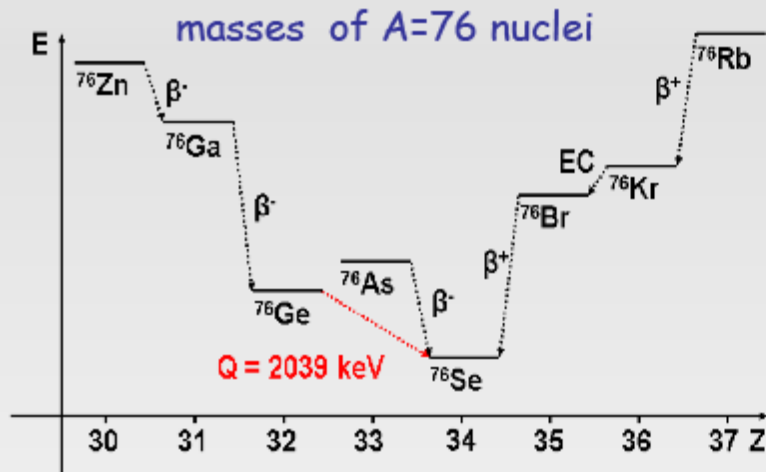

expected for 35 isotopes,
 $2\nu\beta\beta$ found for 11 isotopes

$\beta^+\beta^+, \beta^+\text{EC}$, ECEC rates smaller
 unless resonant enhancement
 (e.g. for $^{152}\text{Gd} - ^{152}\text{Sm}$ ECEC $Q=56 \text{ keV}$,
 Phys Rev Lett 106(2011) 052504)

"single" beta decay not allowed
 → only "double beta decay"

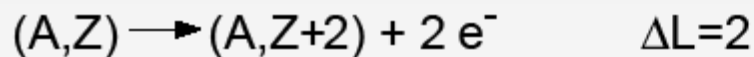
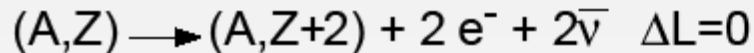

Schechter Valle theorem: $0\nu\beta\beta \iff$ Majorana ν

experimental signature for DBD

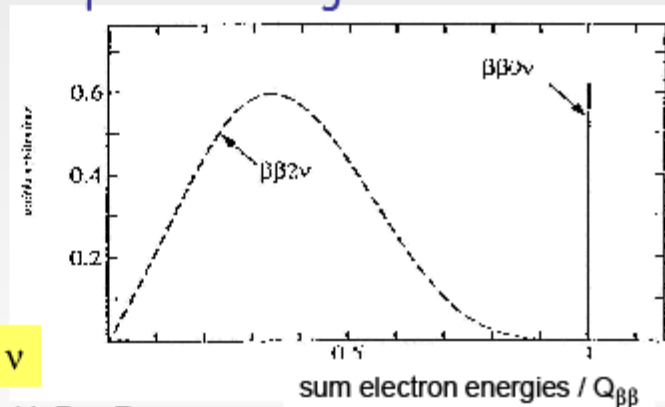

From $T_{1/2}^{0\nu}$ to $\langle m_{ee} \rangle$

$$\frac{1}{T_{1/2}^{0\nu}} = G^{0\nu} |M^{0\nu}|^2 \frac{\langle m_{ee} \rangle^2}{m_e^2}$$

$T_{1/2}^{0\nu}$ = measured experimentally

$G^{0\nu}$ = phase space factor $\sim Q^5$

$M^{0\nu}$ = nuclear matrix element

m_e = electron mass

Experiment observes $N^{0\nu} = \ln 2 \frac{N_A}{A} \cdot a \cdot \epsilon \cdot M t / T_{1/2}$ and $N^{bkg} = M t \cdot B \cdot \Delta E$

Experimental sensitivity

$$T_{1/2}(90\%CL) > \begin{cases} \frac{\ln 2}{2.3} \frac{N_A}{A} a \cdot \epsilon \cdot M t & \text{for } N^{bkg} = 0 \\ \frac{\ln 2}{1.64} \frac{N_A}{A} a \cdot \epsilon \sqrt{\frac{M t}{B \cdot \Delta E}} & \text{for large } N^{bkg} \end{cases}$$

M = mass of detector
 t = measurement time
 A = isotope mass per mole
 N_A = Avogadro constant
 a = fraction of $0\nu\beta\beta$ isotope
 ϵ = detection efficiency
 B = background index in units cnt/(keV kg y)
 ΔE = energy resolution = energy window size

Focus on light neutrino exchange mode

Decay rate depends on an effective Majorana mass. Its calculation requires knowledge of nuclear physics quantities.

$$\left(T_{1/2}^{0\nu}\right)^{-1} = G^{0\nu} \cdot \left|M^{0\nu}\right|^2 \cdot \langle m_{\beta\beta} \rangle^2$$

Phase space

Nuclear matrix element

Because of the imaginary phases cancellations may occur.

$$\langle m_{\beta\beta} \rangle = \left| |m_1| \cdot U_{e1}^2 + |m_2| \cdot U_{e2}^2 \cdot e^{2i\Phi_{12}} + |m_3| \cdot U_{e3}^2 \cdot e^{2i\Phi_{13}} \right|$$

Assumes decay is driven by light neutrino exchange.

Nuclear $0\nu\beta\beta$ -decay ($\bar{\nu} = \nu$)

strong in-medium modification of the basic process $dd \rightarrow uue^-e^-(\bar{\nu}_e\nu_e)$

Light neutrino
exchange mechanism

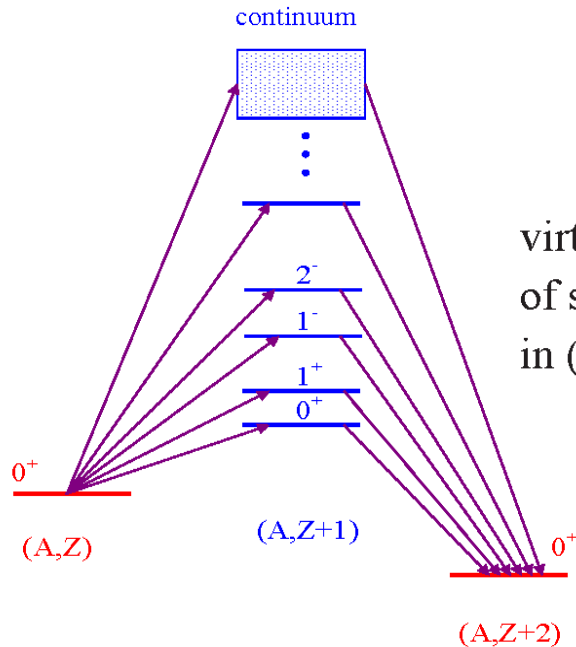
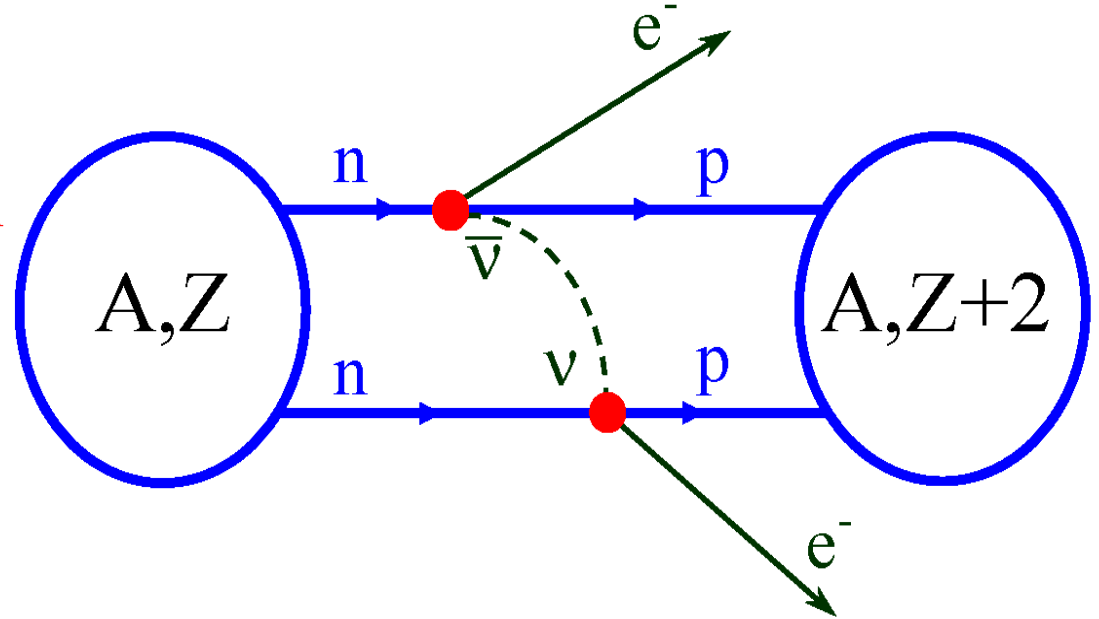

virtual excitation
of states of all multiplicities
in $(A, Z+1)$ nucleus

GT amplitudes to 1^+ states

— from charge-exchange reactions

Nuclear Matrix Elements

$$\left[\mathbf{T}_{1/2}^{0\nu} \right]^{-1} = G_{0\nu} |M_{0\nu}|^2 \langle m_{\beta\beta} \rangle^2$$

Extracting an effective neutrino mass requires an understanding of the nuclear matrix elements (NME) at about the 20% theoretical uncertainty level.

Recent progress NSM-QRPA:
 2005 within $\times 5$
 2012 agree within $\times \sim 2$

Agreement between methods doesn't necessarily provide an estimate of theoretical uncertainties or of actual values.

NME are calculated using different approximate methods: Nuclear Shell Model; Quasi-random phase approximation (QRPA); Interacting Boson Model; Projected Hartree-Fock-Bogoliubov; Generating co-ordinate method extension of PHFB; Pseudo-SU(3) deformed shell model.

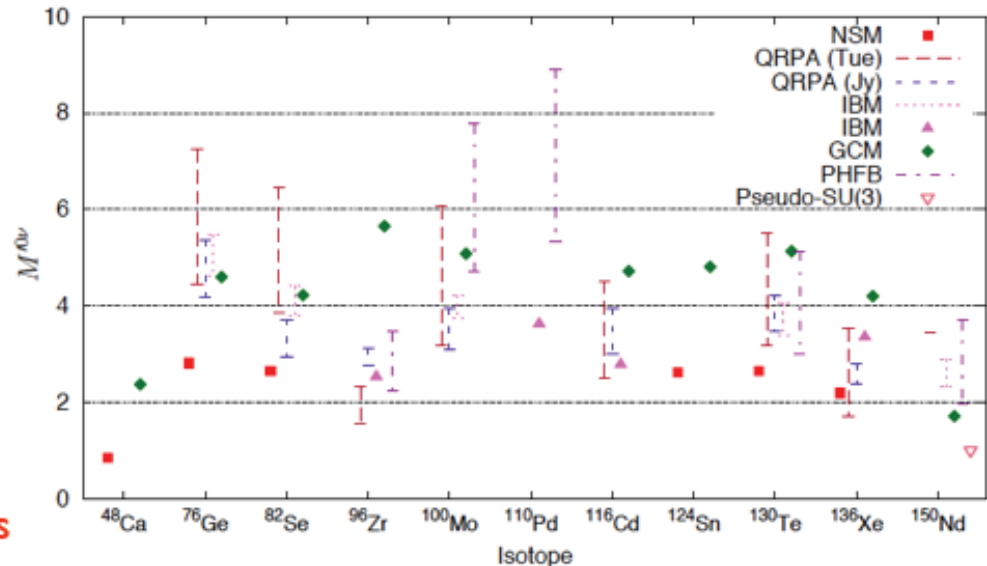

Dueck, Rodejohann & Zuber Phys. Rev. D 63 054031 (2011)
 with $r_0 = 1.2$ fm and $g_A = 1.25$

Germanium for neutrinoless double-beta decay experiments

Germanium detectors

- Source is detector
- Good energy resolution
- Well established technology
- Intrinsically clean (high-purity germanium)

^{76}Ge isotope for $0\nu\beta\beta$

- Q-value of 2039keV above most backgrounds
- Can be enriched to >86% in ^{76}Ge (nat. abundance $\sim 8\%$)
- Slow $2\nu\beta\beta$ rate (10^{21} yr)
- Best limit to date on $0\nu\beta\beta$

Sensitivity and backgrounds - ^{76}Ge

Background free

$$\left[T_{1/2}^{0\nu}\right]^{-1} \propto \epsilon_{\text{eff}} \cdot I_{\text{abundance}} \cdot \text{Source Mass} \cdot \text{Time}$$

Background limited

$$\left[T_{1/2}^{0\nu}\right]^{-1} \propto \epsilon_{\text{eff}} \cdot I_{\text{abundance}} \cdot \sqrt{\frac{\text{Source Mass} \cdot \text{Time}}{\text{Bkg} \cdot \Delta E}}$$

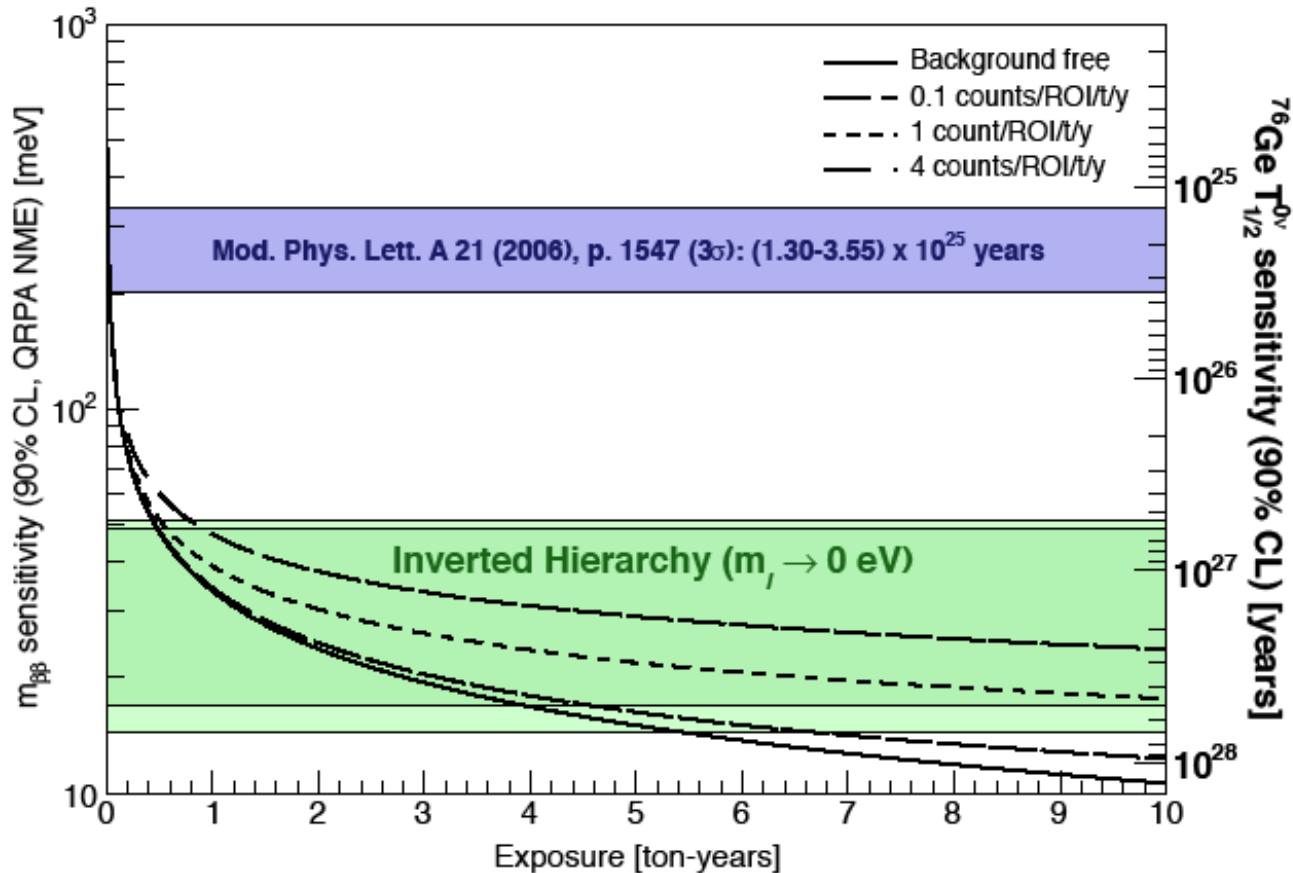

Experiments & sensitivity to $0\nu\beta\beta$ -decay

To reach IH region requires sensitivities of

$0\nu\beta\beta$ $T_{1/2} \sim 10^{26} - 10^{27}$ years

($2\nu\beta\beta$ $T_{1/2} \sim 10^{19} - 10^{21}$ years)

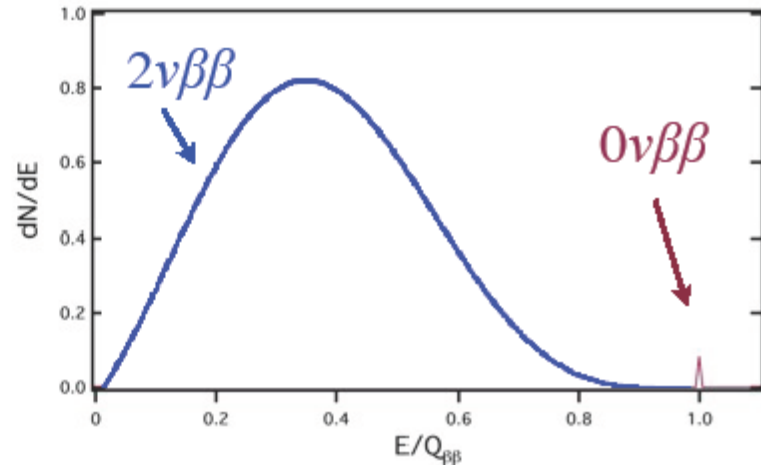

Most sensitive experiments to date using ^{76}Ge , ^{130}Te , and ^{136}Xe have attained $T_{1/2} > 10^{25}$ years

Typical Source Mass · exposure times of 30 - 90 kg-years

$$\left[T_{1/2}^{0\nu} \right]^{-1} \propto \epsilon_{ff} \cdot I_{abundance} \cdot \text{Source Mass} \cdot \text{Time}$$

Background free

$$\left[T_{1/2}^{0\nu} \right]^{-1} \propto \epsilon_{ff} \cdot I_{abundance} \cdot \sqrt{\frac{\text{Source Mass} \cdot \text{Time}}{\text{Bkg} \cdot \Delta E}}$$

Background limited

The MAJORANA Collaboration



Black Hills State University, Spearfish, SD
Kara Keeter, Brianna Mount, **Greg Serfling**, Jared Thompson

Duke University, Durham, North Carolina, and TUNL
Matthew Busch, **James Esterline**, Gary Swift, Werner Tornow

Institute for Theoretical and Experimental Physics, Moscow, Russia
Alexander Barabash, Sergey Konovalov, Vladimir Yumatov

Joint Institute for Nuclear Research, Dubna, Russia
Viktor Brudanin, Slava Egorov, **K. Gusey**,
Oleg Kochetov, **M. Shirchenko**, **V. Timkin**, E. Yakushev

Lawrence Berkeley National Laboratory, Berkeley, California and
the University of California - Berkeley
Nicolas Abgrall, Mark Amman, Paul Barton, Yuen-Dat Chan, **Alex Hegai**,
James Loach, Paul Luke, Ryan Martin, Susanne Mertens, Alan Poon,
Kai Vetter, Harold Yaver

Los Alamos National Laboratory, Los Alamos, New Mexico
Melissa Boswell, Steven Elliott, Johnny Goett, Keith Rielage, Larry
Rodriguez, Michael Ronquest, Harry Salazar, Wenqin Xu

North Carolina State University, Raleigh, North Carolina and TUNL
Dustin Combs, **Lance Leviner**, David G. Phillips II, Albert Young

Oak Ridge National Laboratory, Oak Ridge, Tennessee
Jim Beene, Fred Bertrand, Greg Capps, Alfredo Galindo-Uribarri,
Kim Jeskie, David Radford, Robert Varner, Brandon White,
Chang-Hong Yu

Osaka University, Osaka, Japan
Hiroyasu Ejiri, Ryuta Hazama, Masaharu Nomachi, Shima Tatsuji



Pacific Northwest National Laboratory, Richland, Washington
Estanislao Aguayo, Jim Fast, Eric Hoppe, Richard T. Kouzes, Brian LaFerriere,
Jason Merriman, John Orrell, Nicole Overman, Doug Reid

South Dakota School of Mines and Technology, Rapid City, South Dakota
Adam Caldwell, Cabot-Ann Christofferson, Stanley Howard,
Anne-Marie Suriano

Tennessee Tech University, Cookeville, Tennessee
Mary Kidd

University of Alberta, Edmonton, Alberta
Aksel Hallin

University of North Carolina, Chapel Hill, North Carolina and TUNL
Padraic Finnerty, Florian Fraenkle, **Graham K. Giovanetti**, Matthew P. Green,
Reyco Henning, Mark Howe, **Sean MacMullin**, **Kyle Snavelly**,
Jacqueline Strain, **Kris Vorren**, John F. Wilkerson

University of South Carolina, Columbia, South Carolina
Frank Avignone, **Leila Mizouni**

University of South Dakota, Vermillion, South Dakota
Vince Guisepe, Kirill Pushkin, **Nathan Snyder**

University of Tennessee, Knoxville, Tennessee
Yuri Efremenko, Sergey Vasiliev

University of Washington, Seattle, Washington
Tom Burritt, Jason Detwiler, Peter J. Doe, Greg Harper, **Jonathan Leon**,
David Peterson, R. G. Hamish Robertson, **Alexis Schubert**, Tim Van Wechel



Sanford Underground Research Facility



Sanford Underground Research Facility



SURF Chronology: 2006-2013

- 2006 Homestake donates mine. T. Denny Sanford donates \$70M.
- 2007 NSF selects Homestake to be the DUSEL.
- 2008 Ross Shaft reentry and underground dewatering begin.
- 2009 Yates Shaft reentry and construction on 4850 Level begin.
- 2010 Davis Campus excavation completed. NSB terminates DUSEL funding.
- 2011 Davis Campus outfitting begins. DOE funds operations at \$15M / year.
- 2012 Davis Campus completed. LUX and MAJORANA experiments deploy underground for assembly. Ross Shaft refurbishment begins.
- 2013 LUX begins dark matter search. MAJORANA begins data collection. Designs advance for LBNE and LZ experiments. DIANA site selected.



Sanford Underground Research Facility

The MAJORANA DEMONSTRATOR



Funded by DOE Office of Nuclear Physics and NSF Particle and Nuclear Astrophysics, with additional contributions from international collaborators.

- Goals:**
- Demonstrate backgrounds low enough to justify building a tonne scale experiment.
 - Establish feasibility to construct & field modular arrays of Ge detectors.
 - Test Klapdor-Kleingrothaus claim.
 - Low-energy dark matter (light WIMPs) search.

- **Located underground at 4850' Sanford Lab**
- **Background Goal in the $0\nu\beta\beta$ peak region of interest (4 keV at 2039 keV)**
4 counts/ROI/t/y (after analysis cuts)
scales to 1 count/ROI/t/y for a tonne experiment
- **40-kg of Ge detectors**
 - Baseline: 20-kg of 86% enriched ^{76}Ge crystals & 20-kg of $^{\text{nat}}\text{Ge}$ (up to 30-kg enriched ^{76}Ge)
 - Detector Technology: P-type, point-contact.
- **2 independent cryostats**
 - ultra-clean, electroformed Cu
 - 20 kg of detectors per cryostat
 - naturally scalable
- **Compact Shield**
 - low-background passive Cu and Pb shield with active muon veto

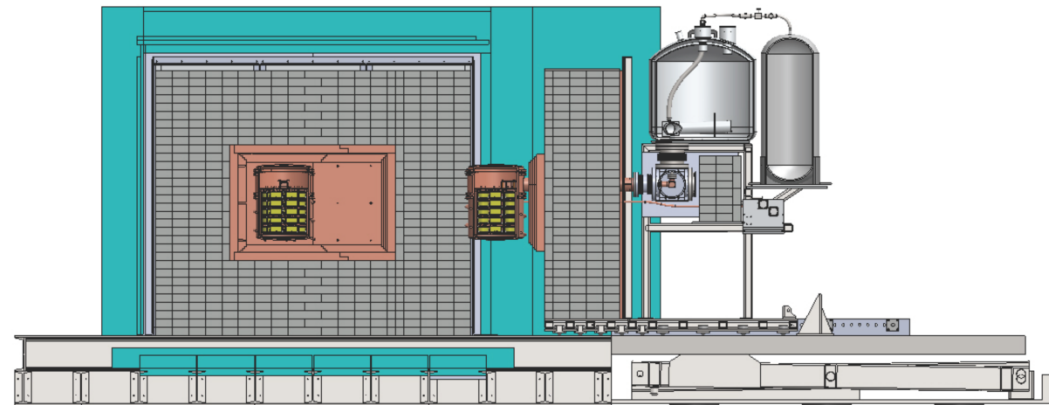
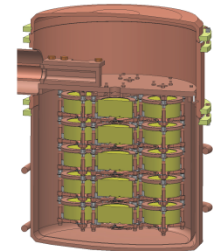

Sensitivity and backgrounds



^{76}Ge Example

$$T_{1/2}^{0\nu} = \ln(2)N\epsilon t/UL(B)$$

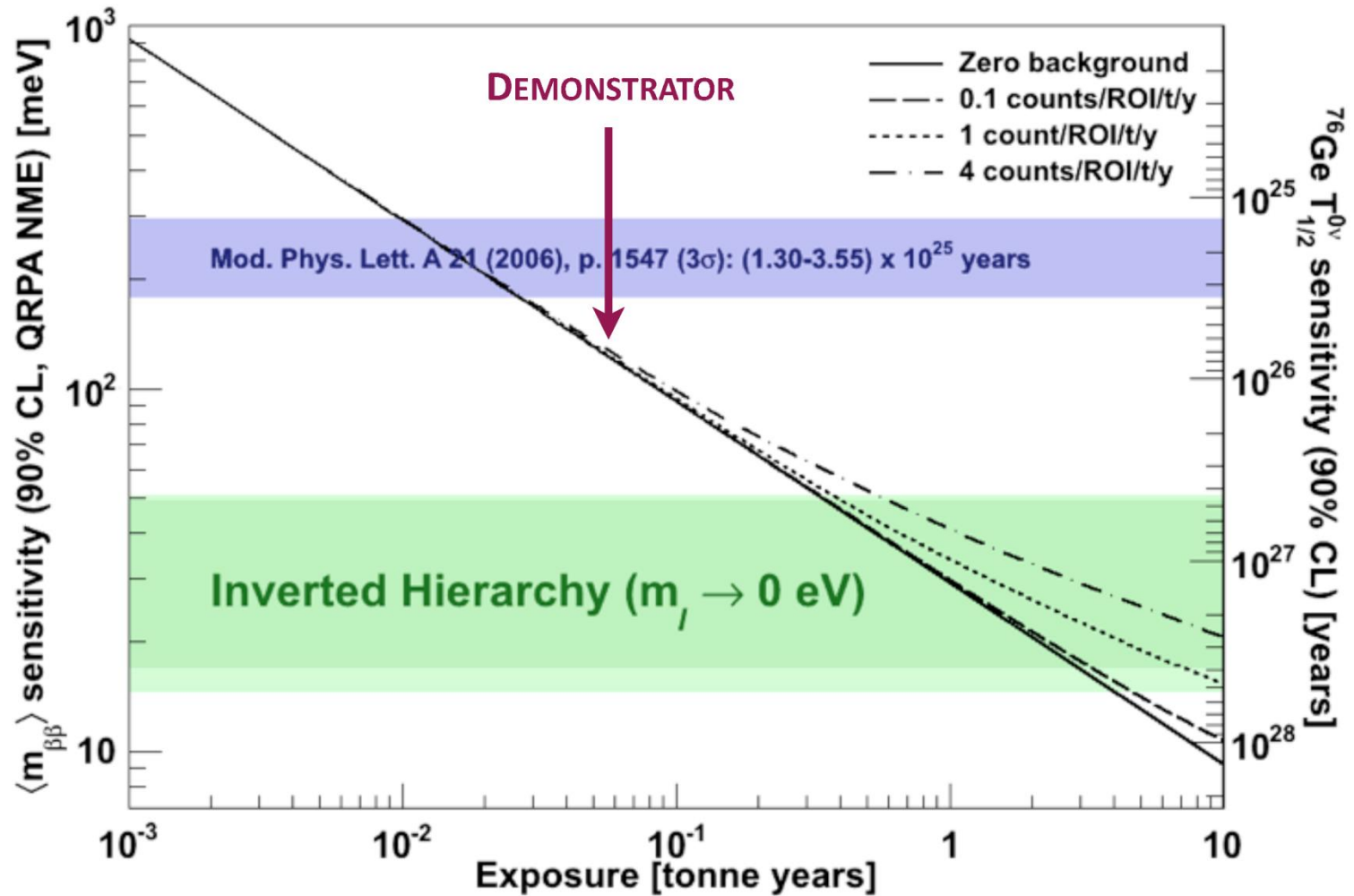



MJD Schedule

MJD will proceed in 3 steps

Prototype Cryostat (Spring 2013):

above ground, commercial copper, 2-3 strings $^{\text{nat}}\text{Ge}$

Test mechanical design

Test detector performance in cryostat and Monte Carlo models (eg. granularity)

Cryostat 1 (Early 2014): underground, electroformed copper, 3 strings $^{\text{enr}}\text{Ge}$, 4 strings $^{\text{nat}}\text{Ge}$

Cryostat 2 (Late 2014): underground, electroformed copper, up to 7 strings $^{\text{enr}}\text{Ge}$



Prototype cryostat

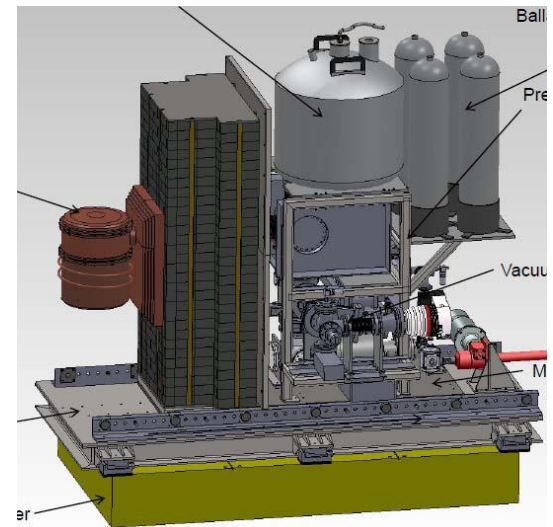

Underground cryostat and “monolith”

Electroforming Copper

- Status
 - For the past 18 months have been operating 16 baths, 10 at 4850L SURF and 6 at shallow UG site at PNNL.
 - Mandrels with Cu pulled from baths at PNNL and TCR. Cu machined, removed, and flattened.
 - Properties look good.
 - Small parts fabricated from EF Cu.
 - All cryostat 1 parts complete.
 - Part of inner shield
- Major remaining activities - 12 months of electroforming remain - cryo 2 parts, inner shield.



MJD Progress in FY13

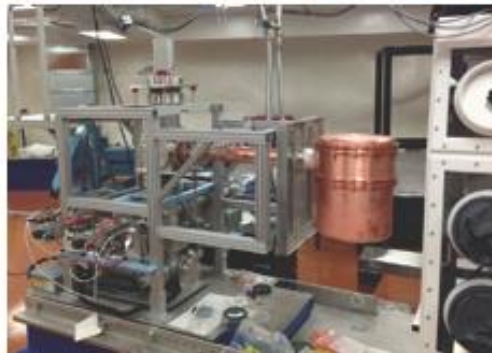

$0\nu\beta\beta$ -decay
Wednesday, February 6, 13

35

NuMass, Feb. 6, 2013

Enriched germanium processing



Enrichment to >86%
at Electro-Chemical
Plant (ECP) in Russia

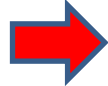

Reduction to Ge metal
at Electrochemical
Systems Inc. (ESI)

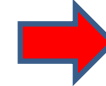

Zone-refinement by
commercial vendor



Detector fabrication by
commercial detector vendor



Pull crystal by
commercial vendor

P-type Point Contact Detectors

- **P-type Point Contact HPGe detectors**
- **“Novel” technology**
- **Small point contact to readout charge, low capacitance**
- **Thick outer contact (n+, lithium diffused), strongly attenuates alphas**

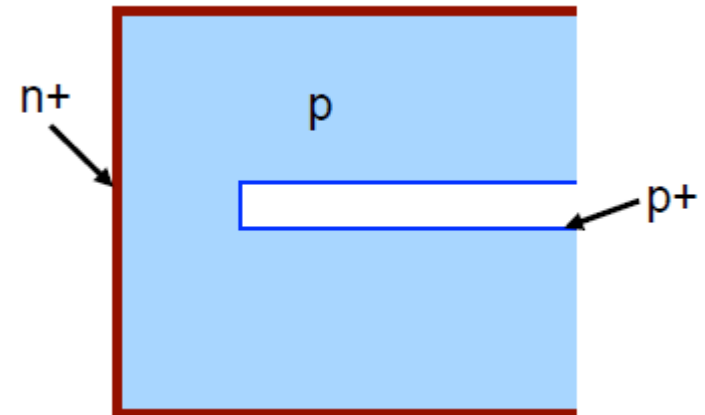

Semi coaxial detector

P. N. Luke, F. S. Goulding, N. W. Madden, R. H. Pehl, IEEE T. Nucl. Sci. **36** (1989) 926
P. S. Barbeau, J. I. Collar, O. Tench, J. Cosmol. Astropart. Phys. **0709** (2007) 009.
E. Aguayo et al. [The Majorana Collaboration],
<http://arxiv.org/abs/1109.6913> (2011)

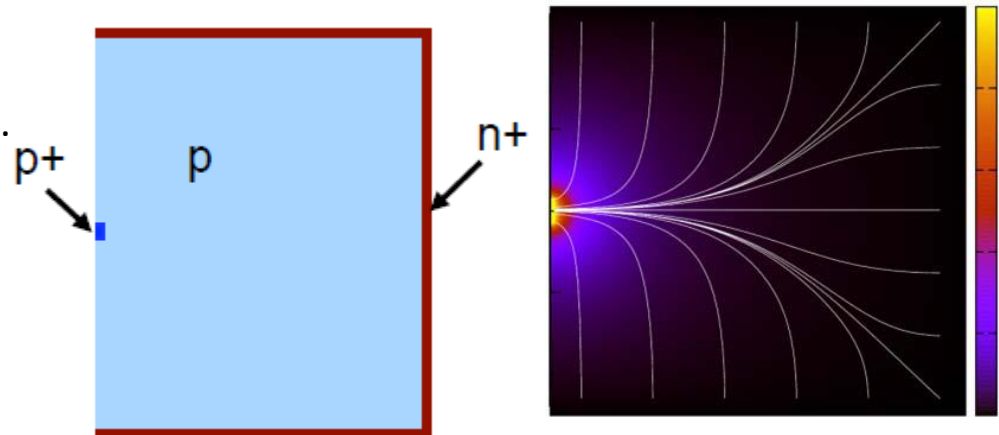

Point contact detector

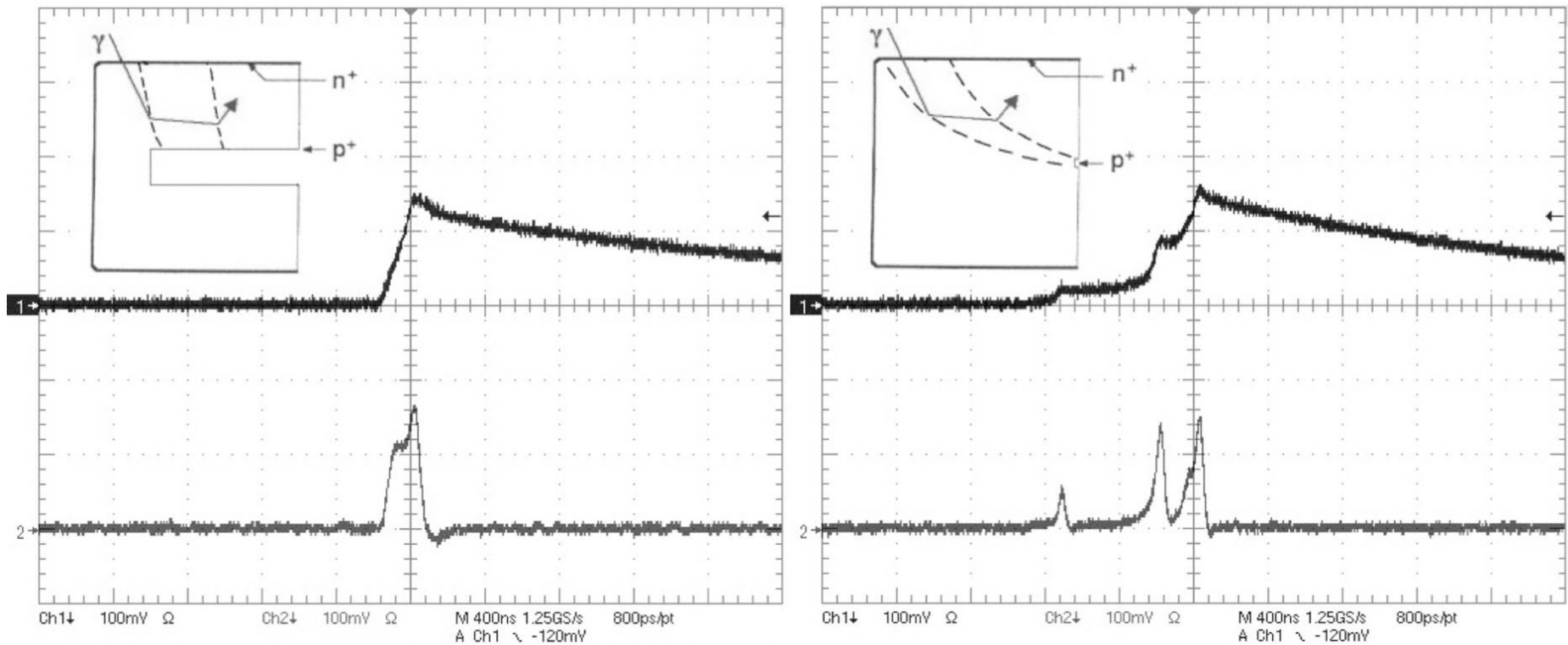

- (Left top) A typical charge pulse of an ordinary semi-coaxial high-purity germanium detector.**
- (Left lower) The corresponding current pulse from differentiating the above pulse.**
- (Right upper) A typical charge pulse from a point contact detector.**
- (Right lower) the current pulse from differentiating the charging pulse above.**

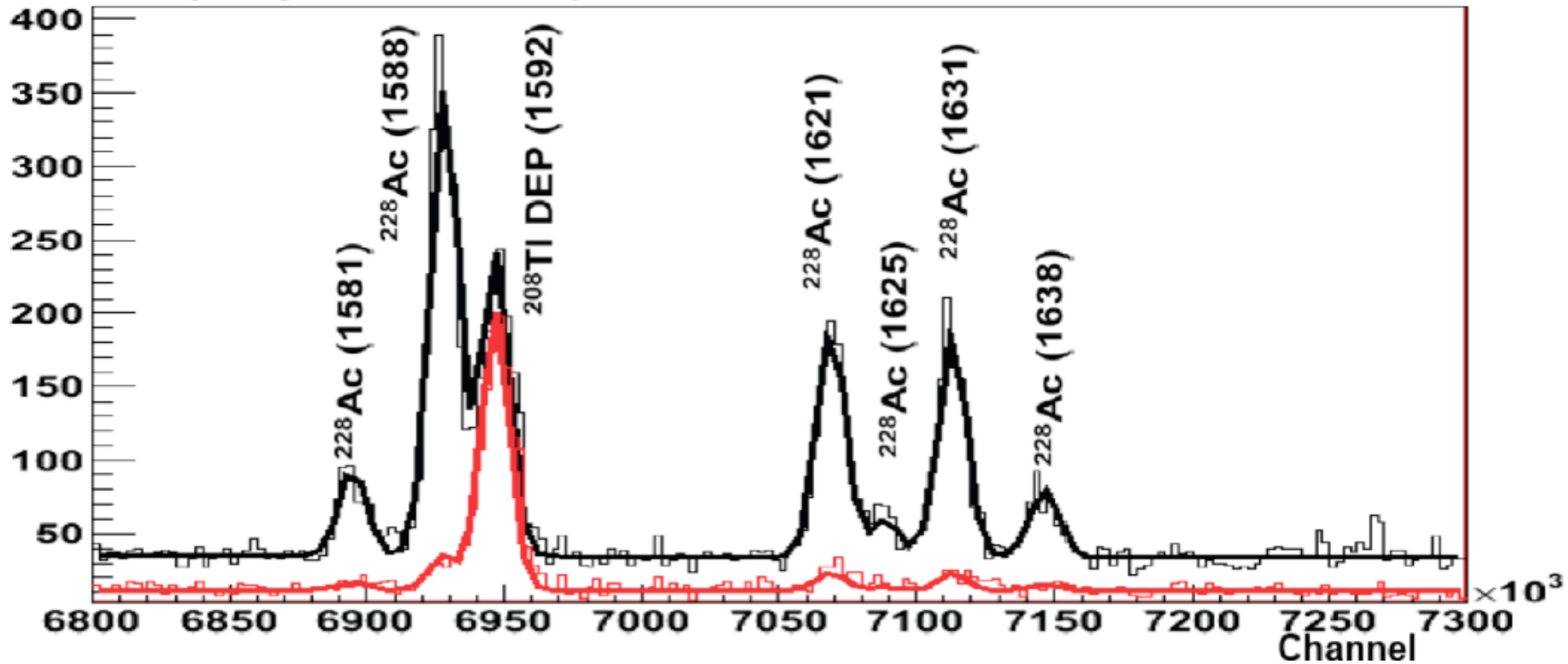

A gamma-ray spectrum taken with a point-contact detector using a ^{232}Th calibration source (Black fitted line). The lines at 1581, 1588, 1621, 1625, 1631, and 1638 keV are full-energy peaks corresponding to gamma rays of those energies, and are dominantly multi-site. The peak at 1592-keV is the double-escape peak from the 2615-keV line in the daughter ^{208}Tl and serves as a proxy for the 0-decay signal. The red spectrum shows the events remaining after the application of PSA cuts to remove multi-site events. A fit to the remnant peaks and background is also shown (red line).

P-type Point Contact Detectors

Low capacitance results in greatly reduced series noise

- opportunity for dark matter search

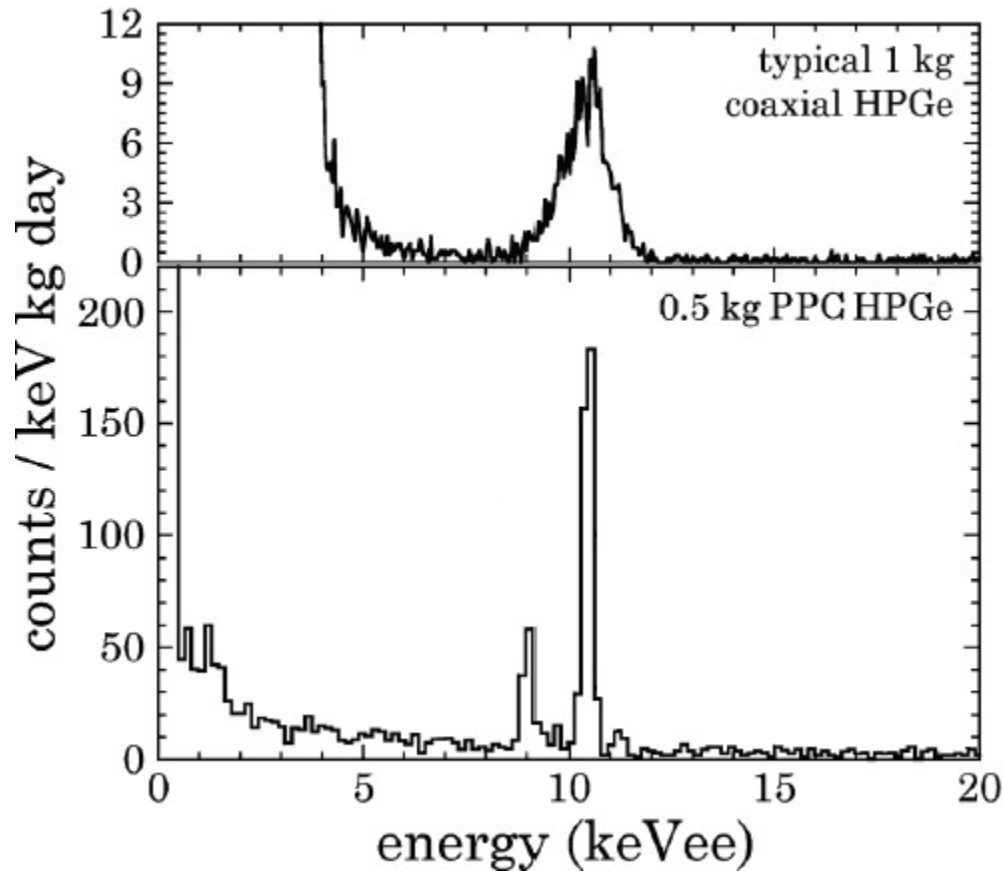

Discovery of $0\nu\beta\beta$ -decay

- **Evidence** : a combination of
 - Correct peak energy
 - Single-site energy deposit
 - Proper detector distributions (spatial, temporal)
 - Rate scales with isotope fraction
 - Good signal to background
 - Full energy spectrum (backgrounds) understood.

Reducing Backgrounds - Two Basic Strategies

- Directly reduce intrinsic, extrinsic, & cosmogenic activities
 - Select and use ultra-pure materials
 - Minimize all non “source” materials
 - Clean passive shield
 - Fabricate ultra-clean materials underground
 - Go deep — reduced μ 's & related induced activities
- Utilize background rejection techniques

$0\nu\beta\beta$ is a single site phenomenon, many backgrounds have multiple site interactions

- Energy resolution
- Active veto detector
- Tracking
- Energy & Angular correlations
- Ion Identification
- Granularity [multiple detectors]
- Pulse shape discrimination (PSD)
- Segmentation
- Single Site Time Correlated events (SSTC)

DEMONSTRATOR background budget

counts in the $0\nu\beta\beta$ region of interest
[counts / 4 keV / tonne-year]

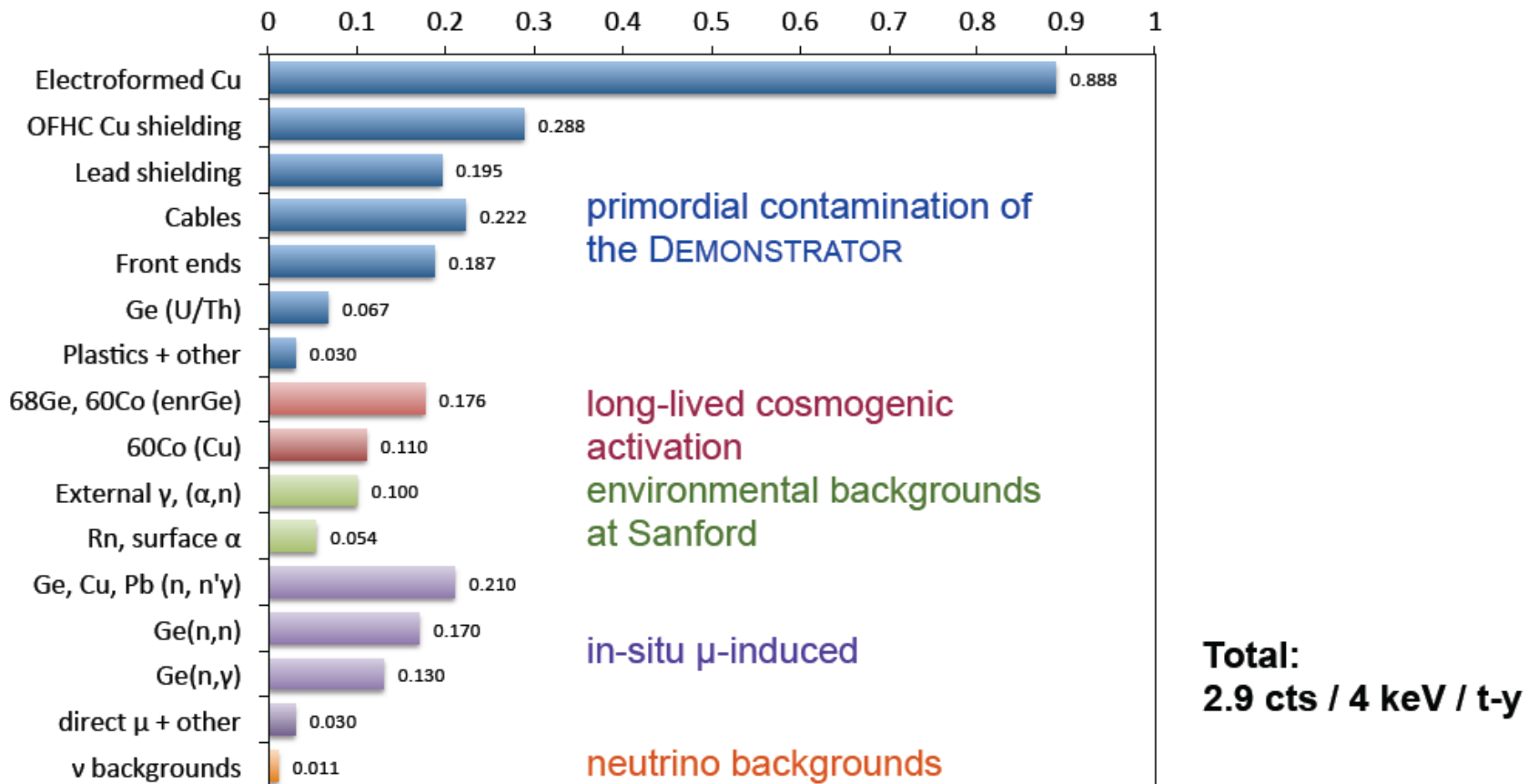

Background mitigation techniques

Granularity

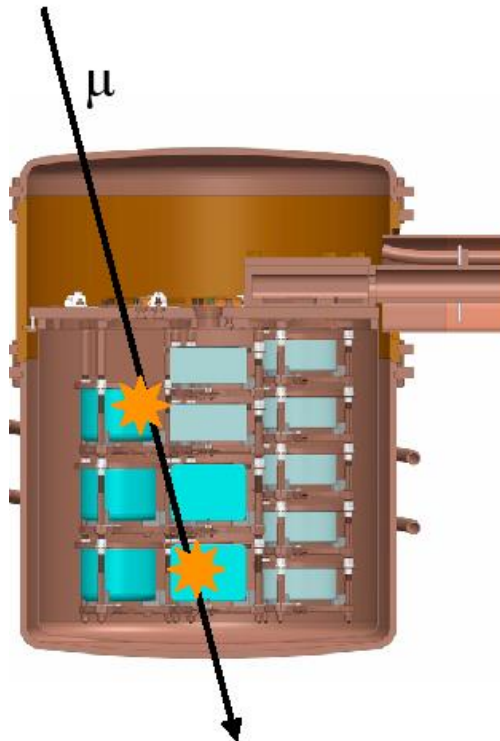

Pulse-shape analysis

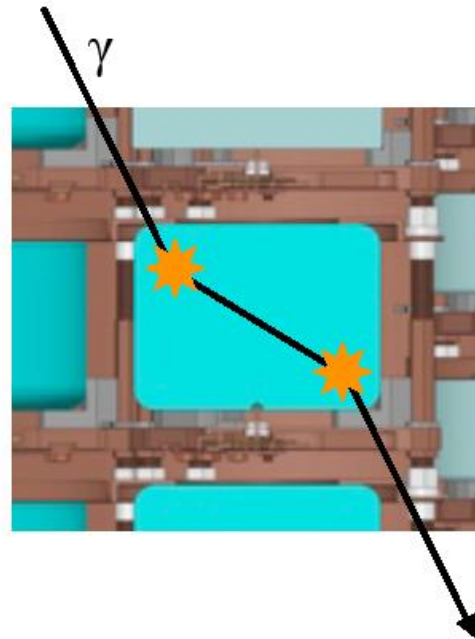

Time correlation

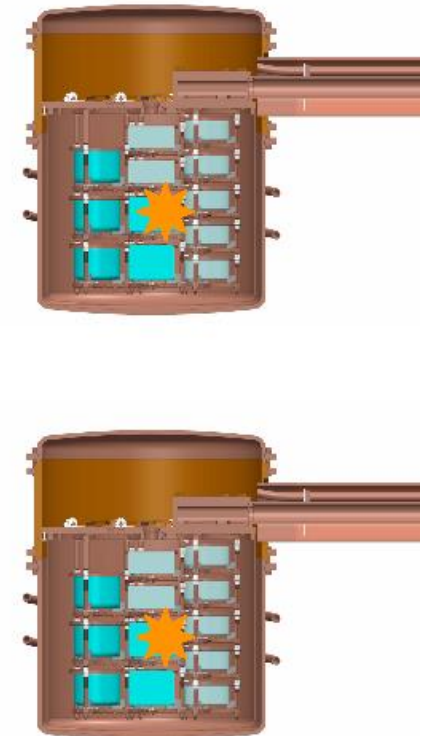

21

Shield Overview

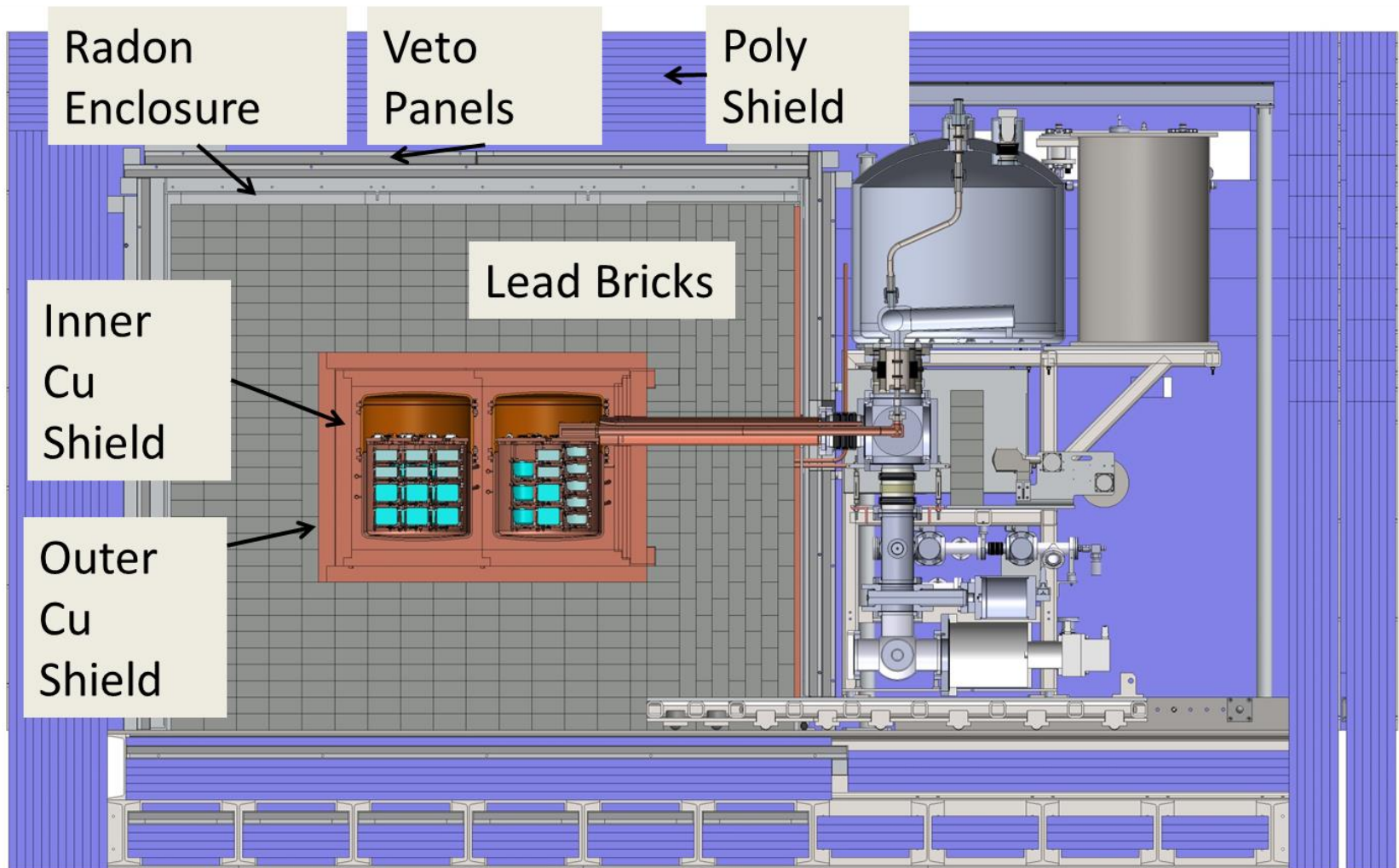

Majorana Active Veto System (Contribution part from UT)

32 veto panels

- Dimensions of individual panels from 0.6 m^2 to 2.0 m^2 .
- Veto should be 99% hermetic
- Panels should be highly efficient for muons (>99%) and other penetrating particles but blind for gammas
- False veto signals should not introduce large dead time.

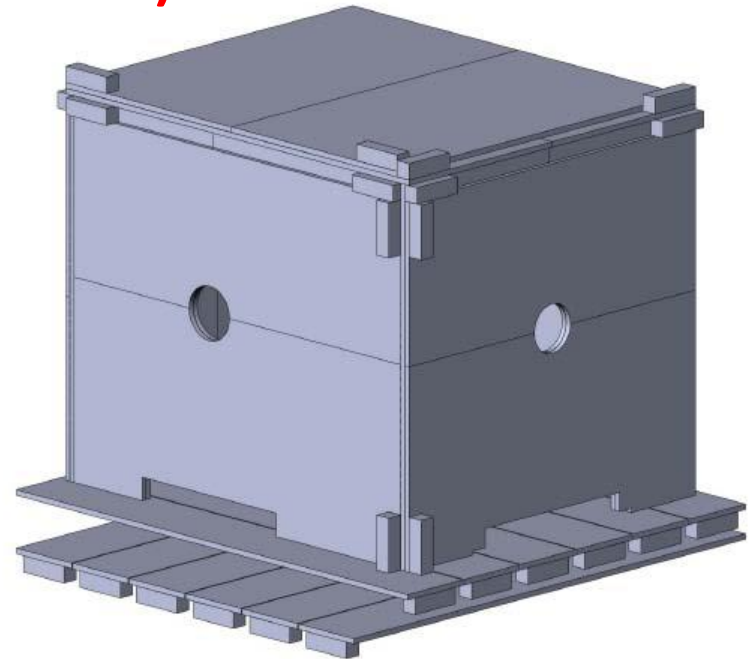

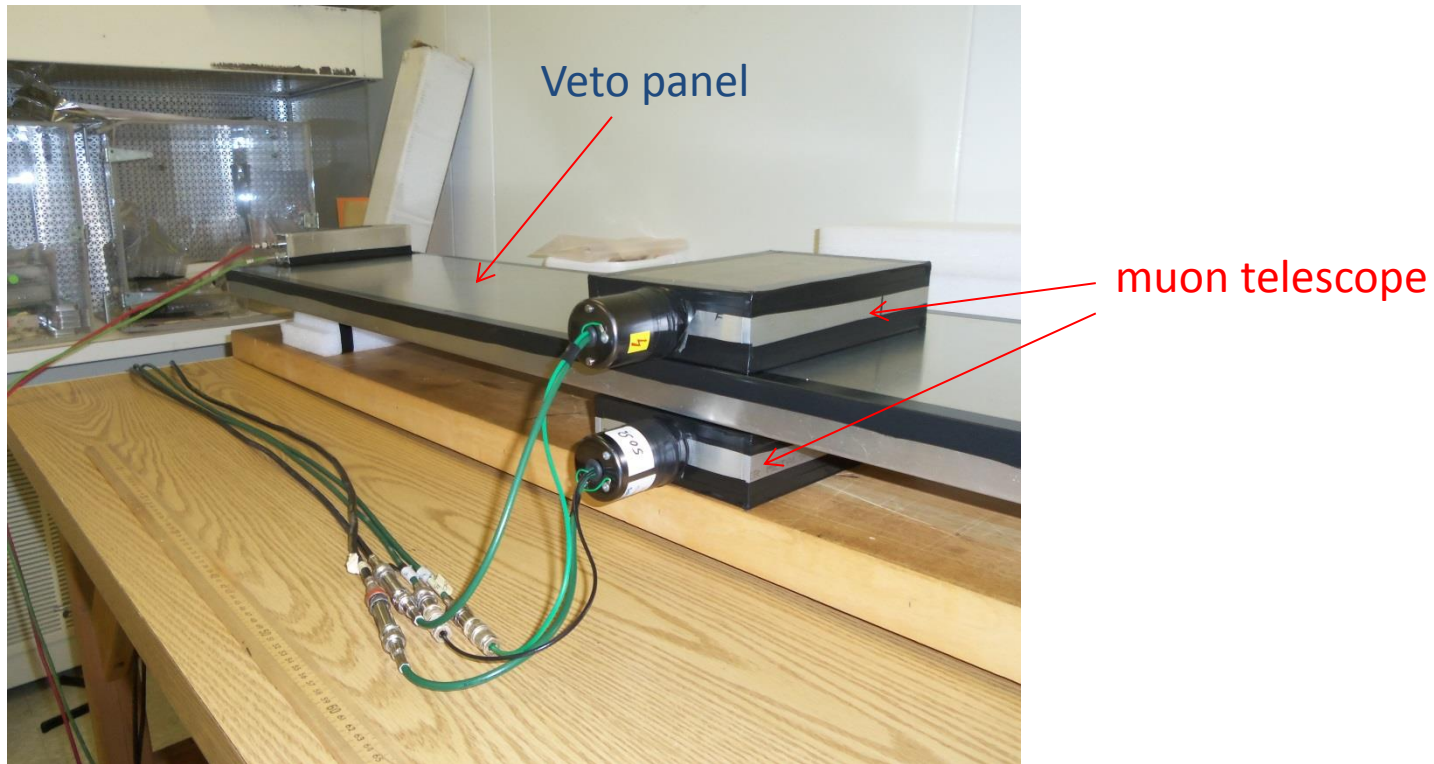

- **All 32 Veto Panels were assembled and tested at SERF (UT, Knoxville)**
- **All 32 Veto panels are shipped to SD**
- **12 Veto panels are operated permanently at SURF in Davis campus since October 2013.**

International Program in $0\nu\beta\beta$

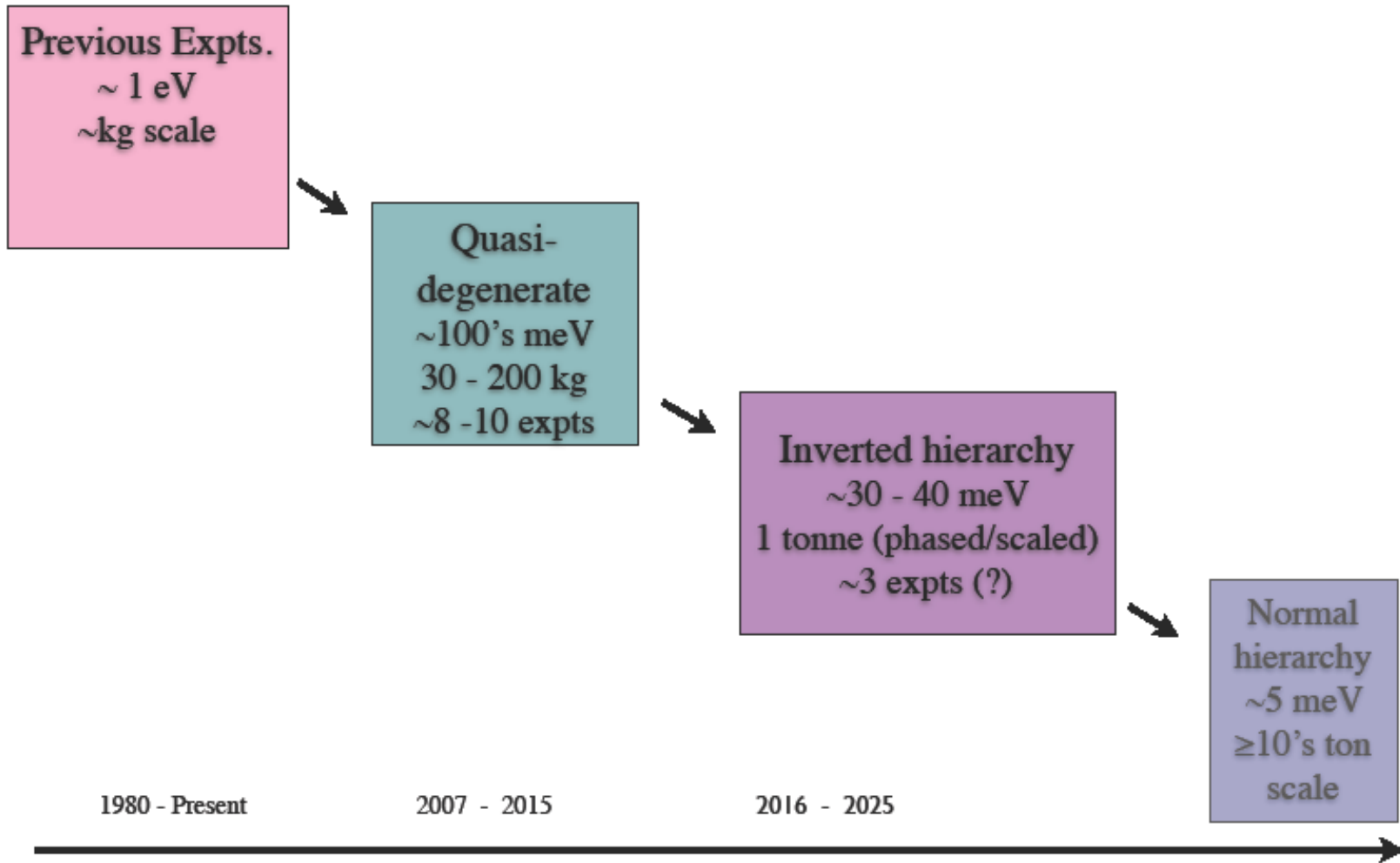

$0\nu\beta\beta$ -decay Summary

- The observation of $0\nu\beta\beta$ -decay would demonstrate Lepton number violation and indicate that neutrinos are Majorana particles - **constituting a major discovery**.
 - Needs to be confirmed from *independent experiments using different isotopes* and measurement techniques.
- If $0\nu\beta\beta$ -decay is observed then it opens an exquisitely sensitive window to search for physics beyond the Standard model.
 - *Measurements in different isotopes* may provide insights into the underlying physics process(es) (η).
 - Extraction of $\langle m_{\beta\beta} \rangle$ will be challenging.

Thanks for your attention!

Backup slides

Sensitivity from now onwards

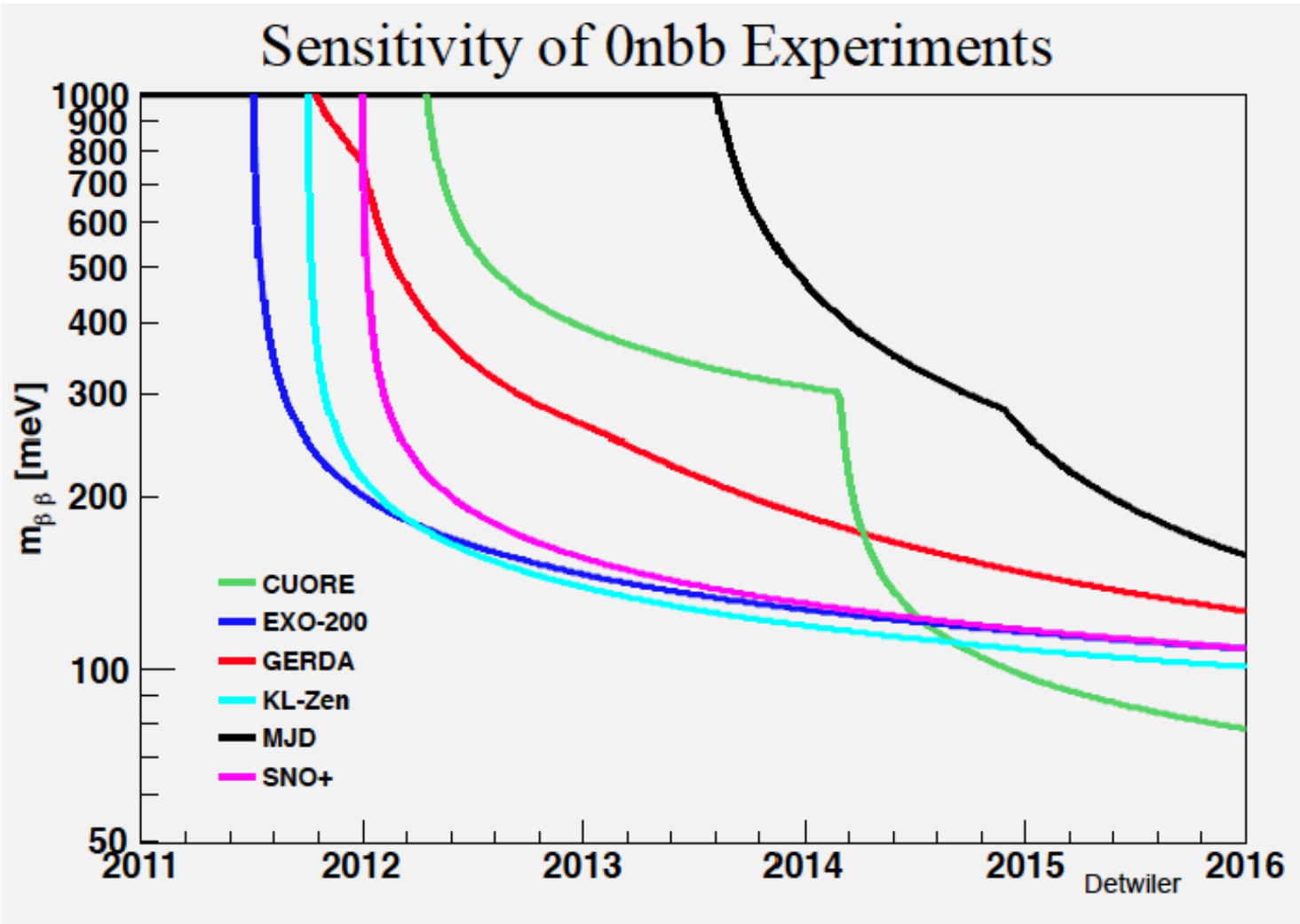

MPLA 16(2001)2409:
5 HP Ge, 1990.08-2000.05,
55.0 kgxy, no PSA, 2.2-3.1 σ effect

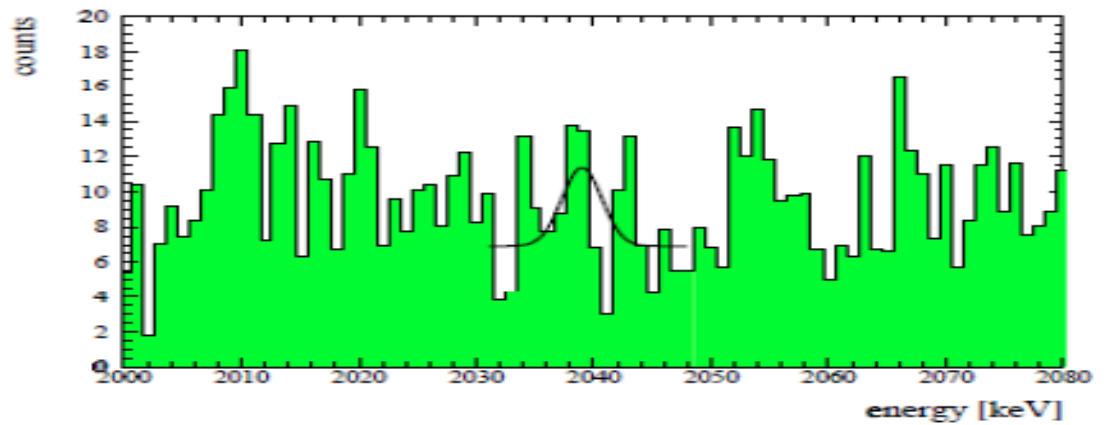

PLB 586(2004)198:
5 HP Ge, 1990.08-2003.05,
71.7 kgxy, no PSA, 4.2 σ effect

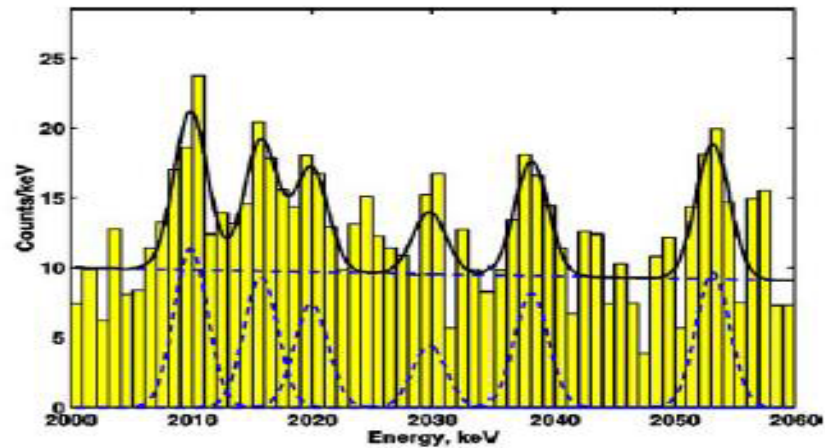

MPLA 21(2006)1547:
4 HP Ge, 1995-2003,
? kgxy, PSA – 2 methods, 6.2 σ effect

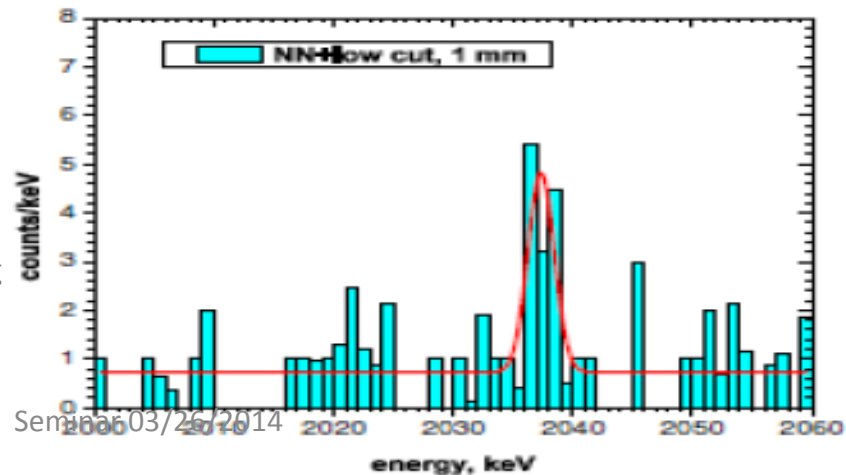

Heidelberg-Moscow experiment:

5 HP Ge detectors (11 kg), 86-88% enriched in ^{76}Ge , Gran Sasso Underground Laboratory (3600 m w.e.), passive shielding, many years of measurements (start in 1990)

There are few articles on this subject:

**0) H.V. Klapdor-Kleingrothaus et al. (HM collaboration, 14 persons),
Eur. Phys. J. A 12 (2001) 147 (received 2001.08.22)**

53.9 kg \times y full statistics (35.5 kg \times y with PSA for single site events):

$T_{1/2}(0\nu) > 1.3(1.9)\times 10^{25}$ yr at 90% C.L.

**1) H.V. Klapdor-Kleingrothaus, A. Dietz, H.L. Harney, I.V. Krivosheina,
Mod. Phys. Lett. A 16 (2001) 2409 (received 2001.12.05)**

55.0 kg \times y full statistics (no PSA), $T_{1/2}(0\nu) = 1.6\times 10^{25}$ yr [(0.8-35.1) $\times 10^{25}$ yr at 95% C.L.]

46.5 kg \times y part of statistics (no PSA), $T_{1/2}(0\nu) = 1.5\times 10^{25}$ yr [(0.8-18.3) $\times 10^{25}$ yr]

2.2-3.1 σ effect

Criticized in number of works:

F. Feruglio et al., Nucl. Phys. B 637 (2002) 345

C.E. Aalseth et al., Mod. Phys. Lett. A 17 (2002) 1475

Yu.G. Zdesenko et al., Phys. Lett. B 546 (2002) 206

A. Ianni, Nucl. Instrum. Meth. A 516 (2004) 184

| no effect or $\sim 1.5\sigma$ effect

Also, Moscow part of the H-M collaboration derived only limit:

$T_{1/2}(0\nu) > 1.6 \times 10^{25}$ yr at 90% C.L.

A.M. Bakalyarov et al., Phys. Part. Nucl. Lett. 2 (2005) 21

**2) H.V. Klapdor-Kleingrothaus, I.V. Krivosheina, A. Dietz, O. Chkvorets,
Phys. Lett. B 586 (2004) 198**

71.7 kg×y full statistics (no PSA), $T_{1/2}(0\nu) = 1.2 \times 10^{25}$ yr [(0.7-4.2)×10²⁵ yr at 95% C.L.]

4.2σ effect

Not only statistics was bigger; also summing procedure was improved:

Final spectrum = sum of 9570 individual spectra

**360 calibration spectra for each of 5 detectors, FWHM(2615 keV)=3.27 keV for sum of
1800 calibration spectra**

3) H.V. Klapdor-Kleingrothaus, I.V. Krivosheina, Mod. Phys. Lett. A 21 (2006) 1547

? kg×y, PSA – 2 methods (pulse shapes were written since 1995)

$T_{1/2}(0\nu) = 2.23^{+0.44}_{-0.31} \times 10^{25}$ yr – final result

6.2σ effect